



HIGH SPEED
ENGINEERING
PRECISION CNC MACHINING

Capability & Services Brochure



15 Masonry Way
MALAGA WA 6090

P: 08 9248 1399

E: admin@highspeedengineering.com

W: www.highspeedengineering.com



Capability Statement

Specialised Computer Numerical Control (CNC) Manufacturing & Other Technologies.
Technical Design & Drafting Services including Reverse Engineering & Metrology.
Specialised Service Provider for Mining, Heavy Rail, Scientific, Motorsport, General Engineering, Valves, Subsea, Oil & Gas and other Industries.

Manufacturing

Milling:	3, 4 & 5 Axis CNC Machining Centres including 10 Pallet Machine
Turning:	3, Y and C Axis Lathes
Wirecutting:	5 & 6 Axis Wirecutters including Excetek V650G Plus
Gear Hobbing:	4 Axis CNC
Welding:	Robotic Mig Welder ABB IRB
Laser Cutting:	1500x1500mm up to 25mm steel

Design

Metrology:	Coordinate Measuring Machine (CMM) to 0.002mm accuracy & Faro Arm
Laser Scanning:	MOPA, Fibre and CO2
Additive Printing:	FDM & Resin
Design & Drafting:	SolidWorks

Other

Exotic Metal Machining **Surface Grinding** **Polishing & Finishing** **Spark Eroding**
Light Fabrication **Assembly** **Tooling**





Machining Capabilities & Services 1/6

MILLING

BRAND	MODEL	AXIS	X (MM)	Y (MM)	Z (MM)
HAAS 10 PALLET	UMC500SS	5	610	406	406
HAAS	UMC750SS	5	762	508	508
DOOSAN	DVF 500	5	625	450	400
HAAS	VF5	3-Apr	1270	660	800 (under spindle)
HAAS	VF5XT	3-Apr	1550	660	800 (under spindle)
MITSEIKI	CV1200	3-Apr	1200	600	700 (under spindle)
HAAS	VF2SS	3	750	412	500 (under spindle)

8, 10 and 12" ROTARY TABLES



TURNING

BRAND	MODEL	AXIS	DIA. (MM)	LENGTH (MM)	CHUCK (")
DN SOLUTIONS	GT2100	2	400	560	10
DN SOLUTIONS PUMA	2600YB2	Y Milling	400	790	12
DOOSAN LYNX	220LY	Y Milling	320	550	8
PUMA	400	2	580	1100	15
DAEWOO LYNX	210L	2	280	550	8
DAEWOO LYNX	210L	2	280	550	8
DAEWOO PUMA	240M	C Milling	280	550	8
VICTOR	V600	2	650 (turning)		15
DAEWOO PUMA	10	2		750	10
HAAS	TL1	2	300	750	8



WIRECUTTING

BRAND	MODEL	AXIS	X (MM)	Y (MM)	Z (MM)
EXCETEK	V650G Plus	5	650	400	500
EXCETEK	V400G	5	400	300	240
EXCETEK	V400 + Rotary	6	400	300	300
FANUC	Alpha-OC	5	320	220	180



GEARHOBBING

BRAND	AXIS	DIA. (MM)	Z (MM)
BORUI	4	550	350

LASER ETCHING & CUTTING

BRAND	MODEL	X (MM)	Y (MM)	FEATURES
ACCTEK	MOPA Fiber	600	900	30W
ACCTEK	Fiber	300	300	30W
BODOR	CO2	600	900	100W
LASER CUTTER	6KW FIBRE LASER	1500	1500	Up to 25mm STEEL



EDM SPARK ERODERS

BRAND	MODEL	X (MM)	Y (MM)	Z (MM)	FEATURES
CHMER	50MP	400	300	Z (MM)	FEATURES
KOTON	KS400	700	400	500	



ADDITIVE PRINTING

TYPE	X (MM)	Y (MM)	Z (MM)
5 x FDM	300	300	300
3 x Resin	300	300	160

ROBOTIC MIG WELDING

ABB IRB 2600 7aXIS 350

Machining Capabilities & Services 2/6

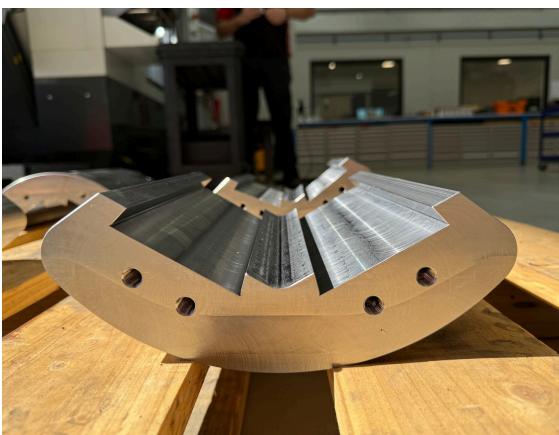
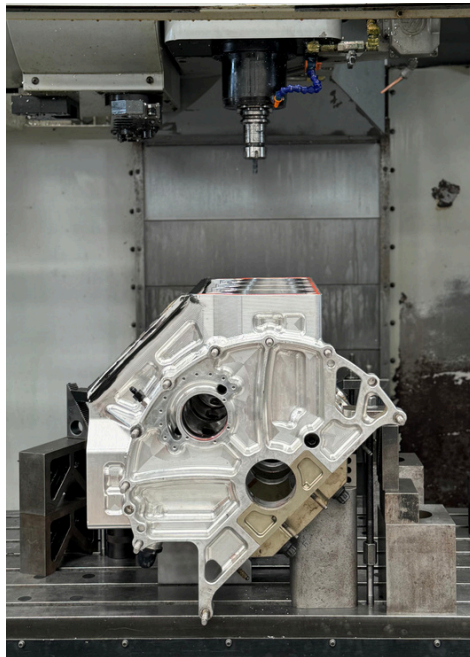
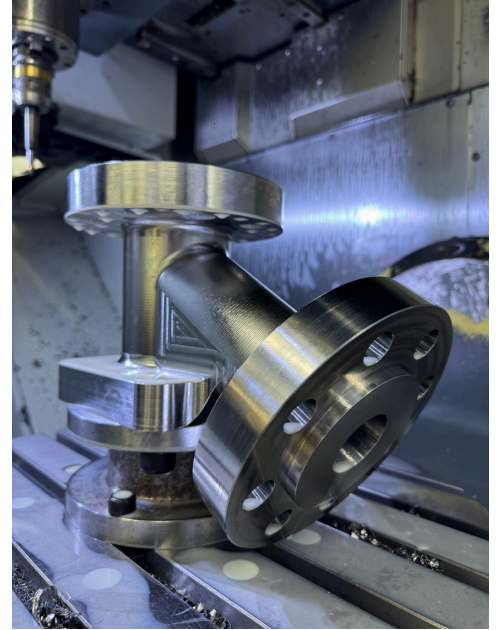
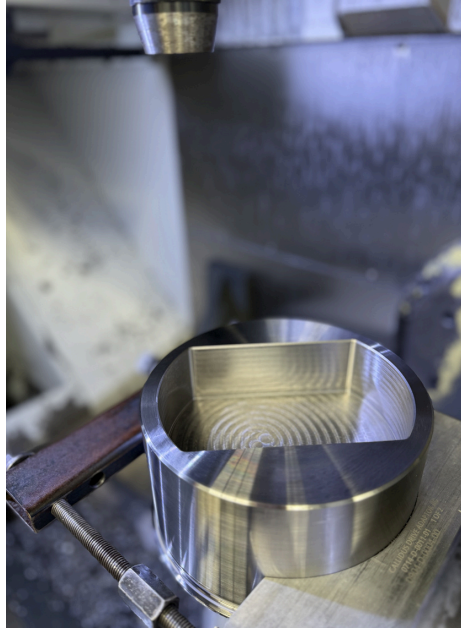
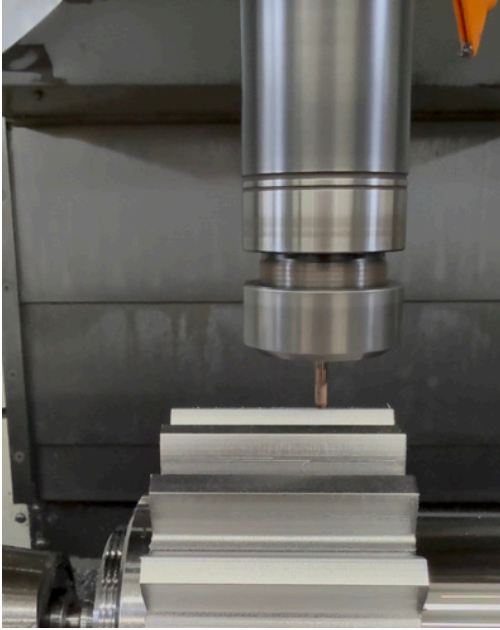

Machining Capabilities & Services 3/6

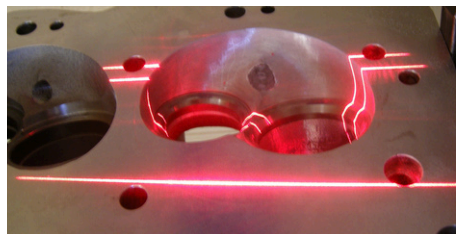
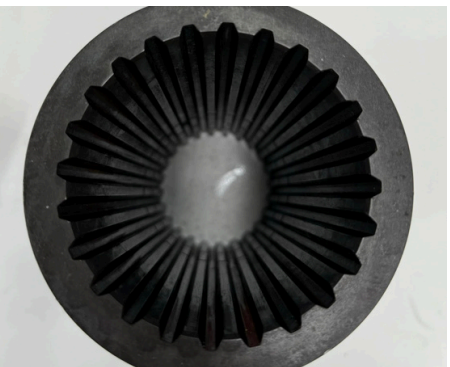
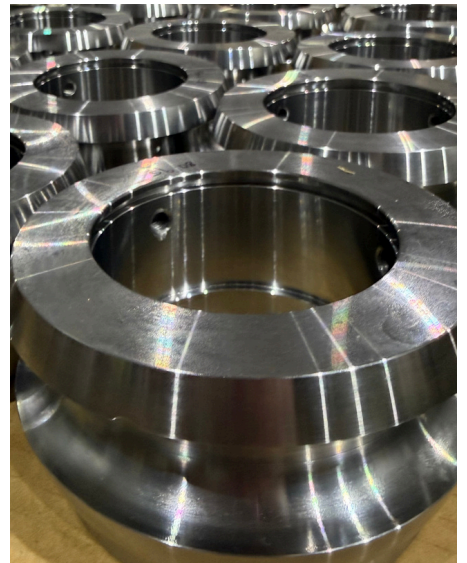
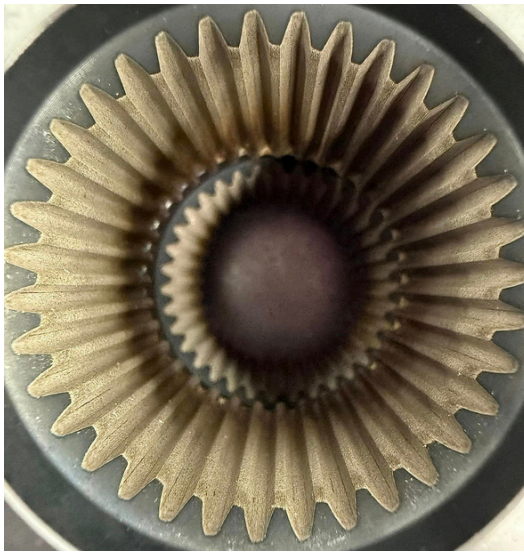
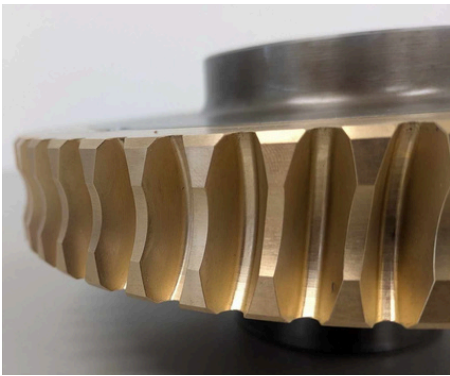
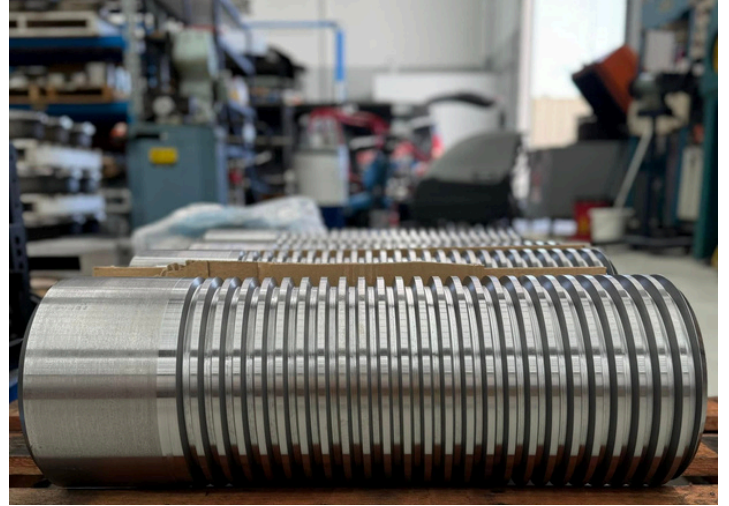



Machining Capabilities & Services 4/6

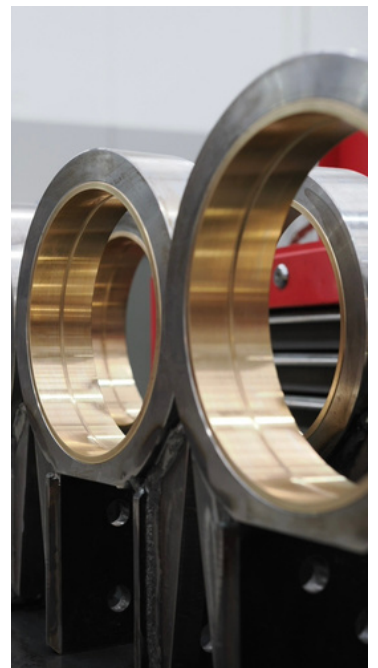
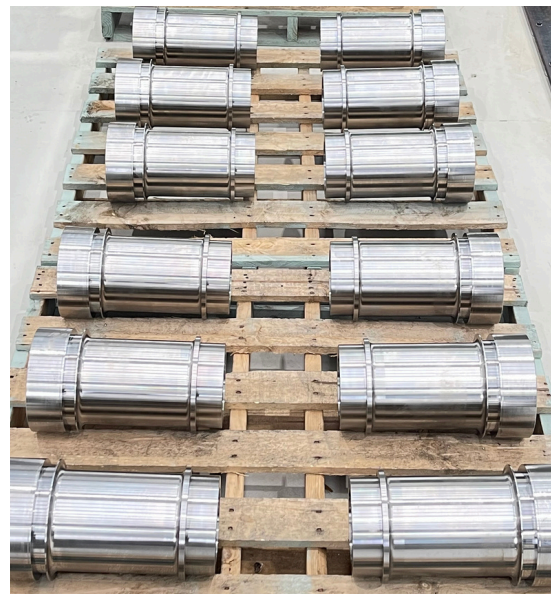
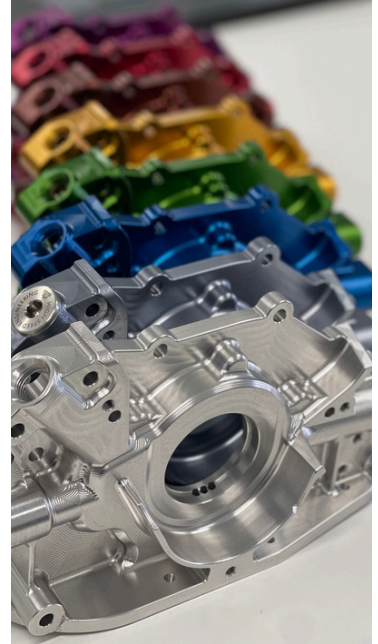
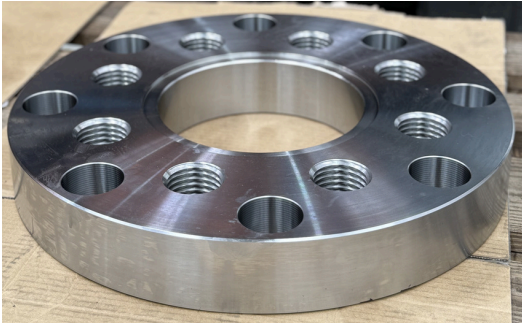
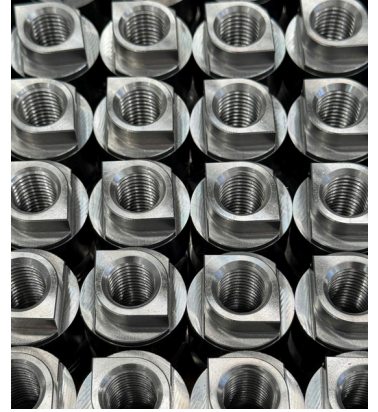



Machining Capabilities & Services 5/6

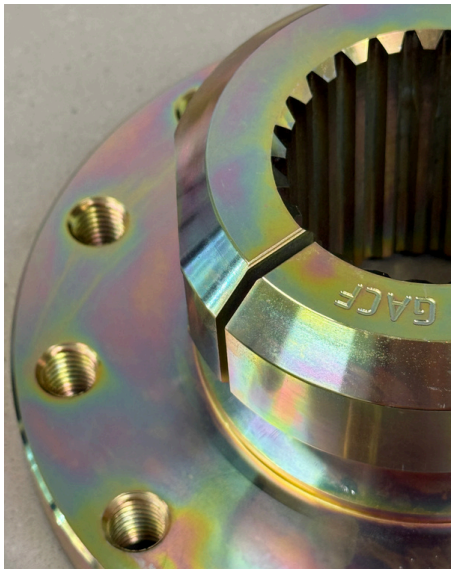
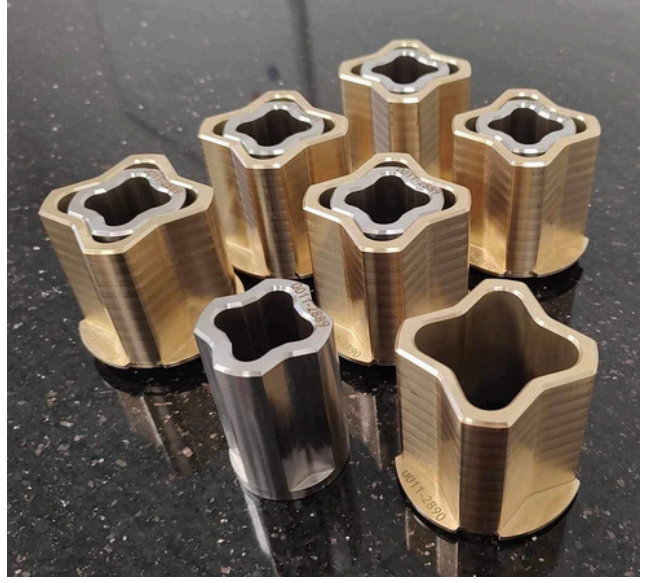
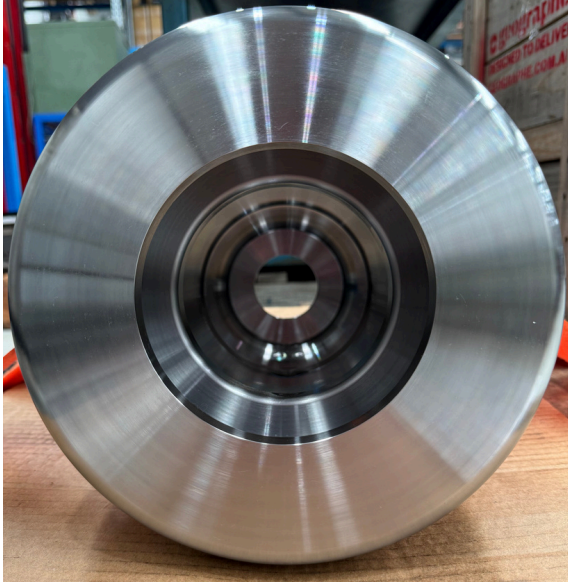



Machining Capabilities & Services 6/6

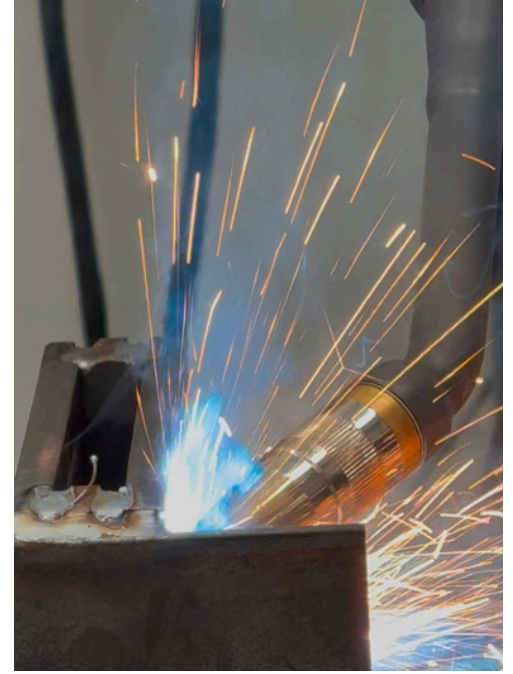

Bearings, Fastenings, Couplings, Bushes and Fixings

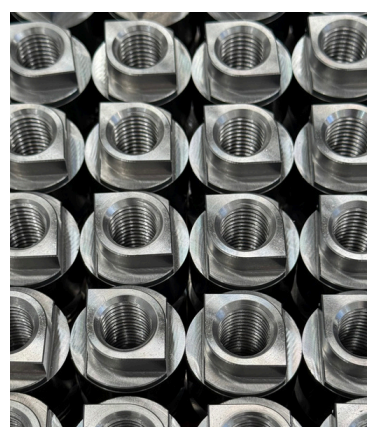
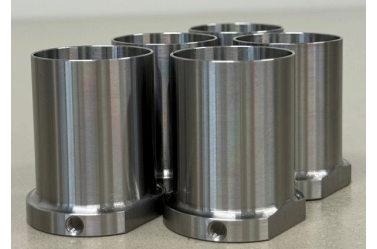
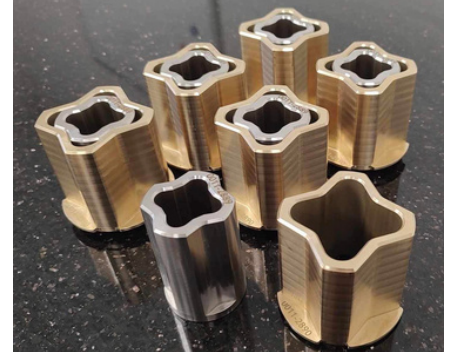
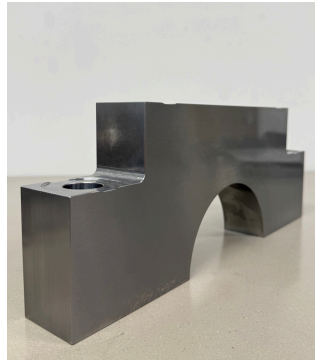
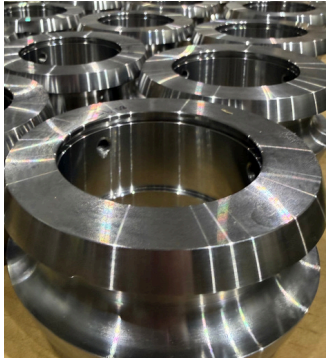



15 Masonry Way
MALAGA WA 6090
P: 08 9248 1399
E: admin@highspeedengineering.com
W: www.highspeedengineering.com



Gears

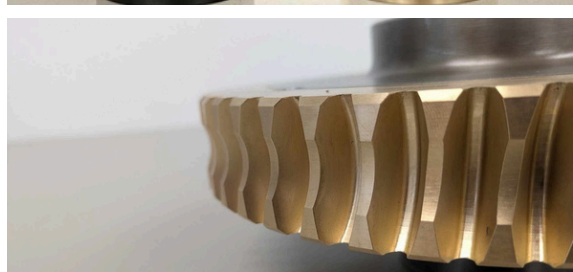
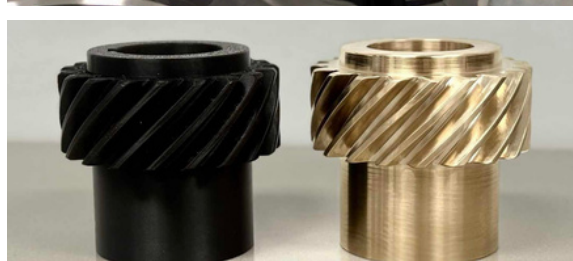
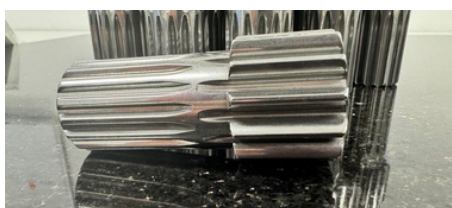

**HIGH SPEED
ENGINEERING**
PRECISION CNC MACHINING



15 Masonry Way
MALAGA WA 6090

P: 08 9248 1399

E: admin@highspeedengineering.com

W: www.highspeedengineering.com



Valve & Valve Components

Exceptional Accuracy, Consistent Quality.

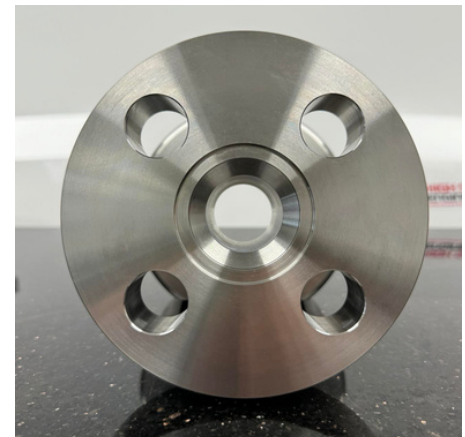
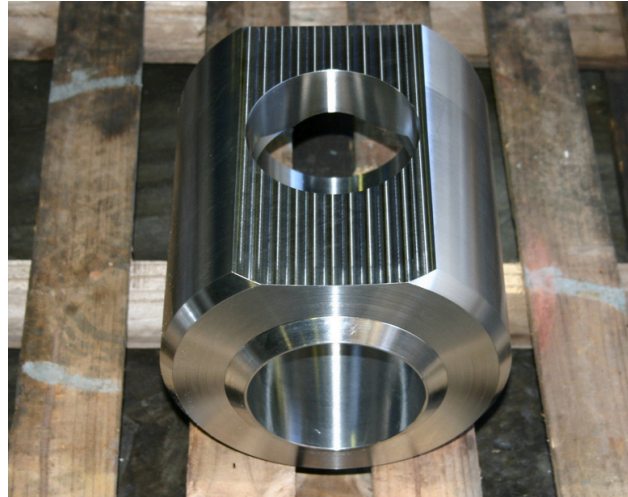
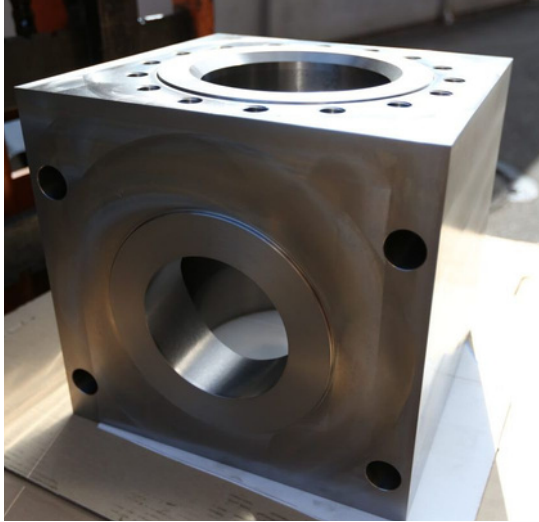
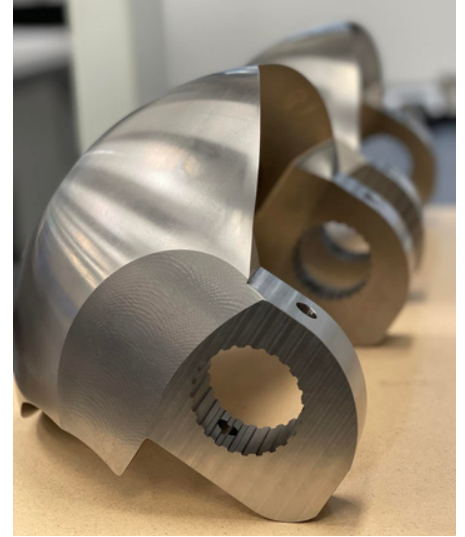
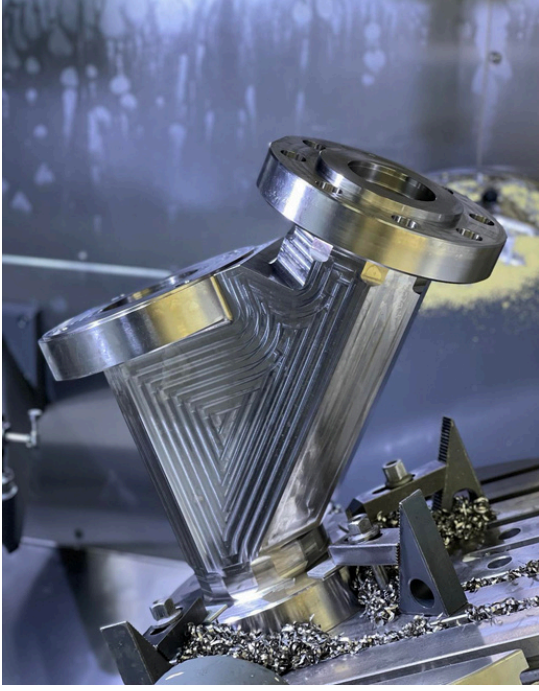



Wirecutting

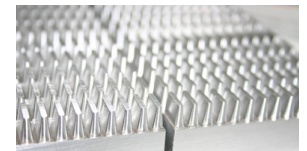
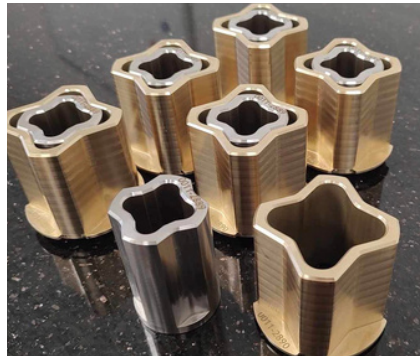
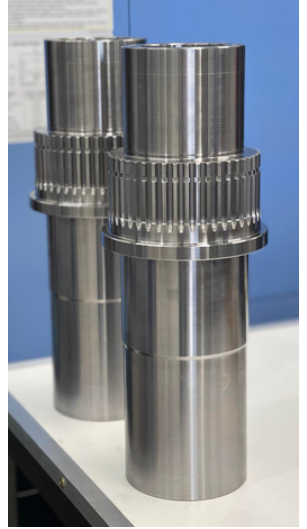
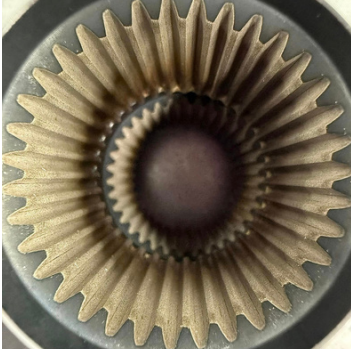

Additive Manufacturing

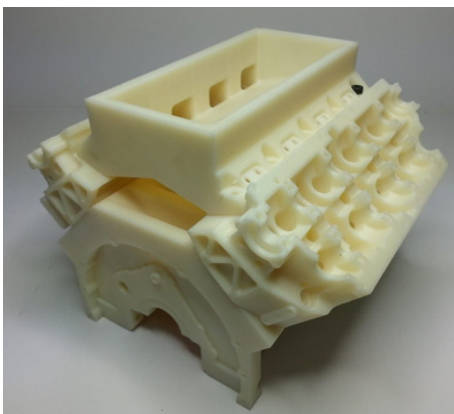
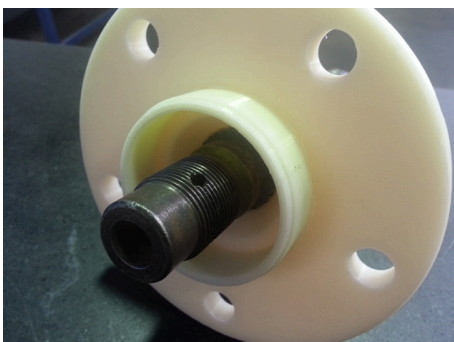
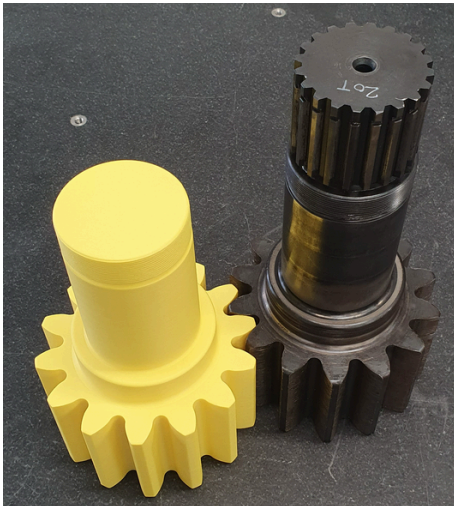



15 Masonry Way
MALAGA WA 6090
P: 08 9248 1399
E: admin@highspeedengineering.com
W: www.highspeedengineering.com



Mechanical Consultancy

3D LASER SCANNING CAD/CAM DRAFTING PRODUCT IMPROVEMENTS
CONCEPT DESIGN PROTOTYPING REVERSE ENGINEERING

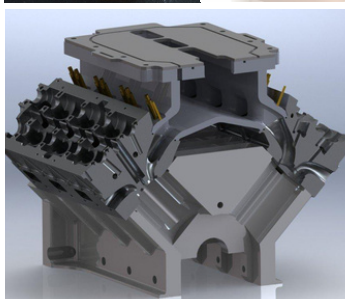
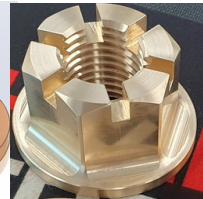
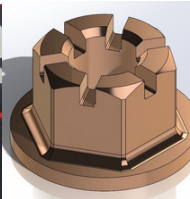
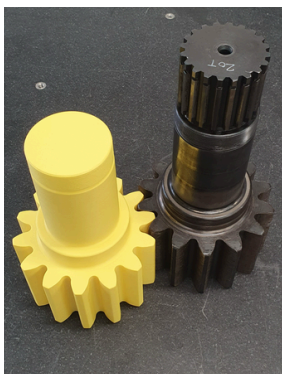
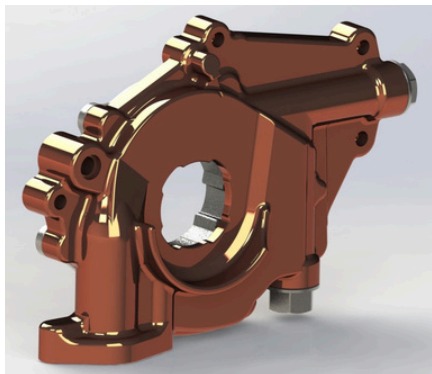
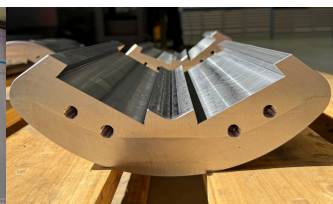
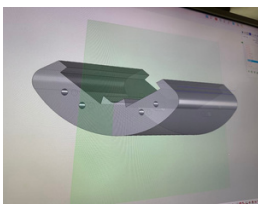
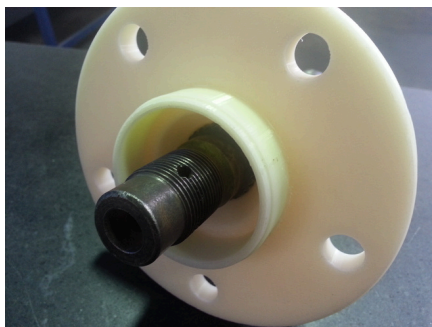
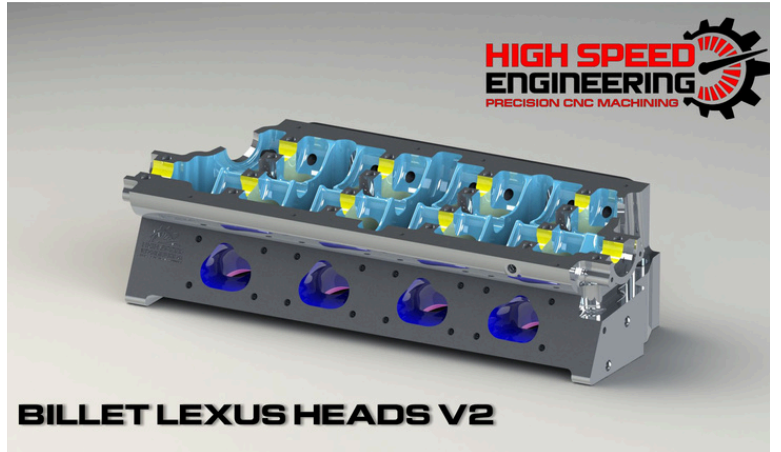
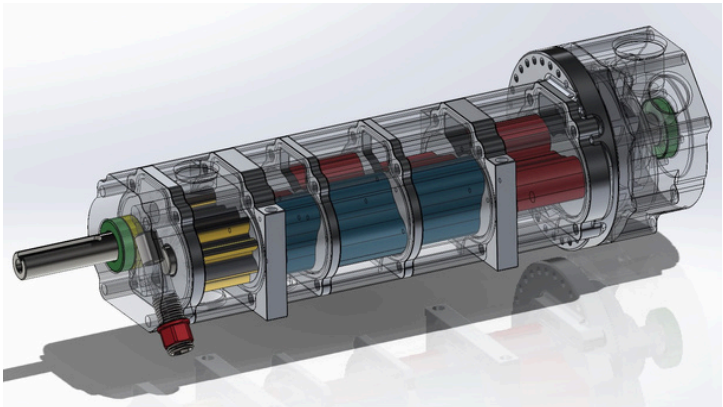
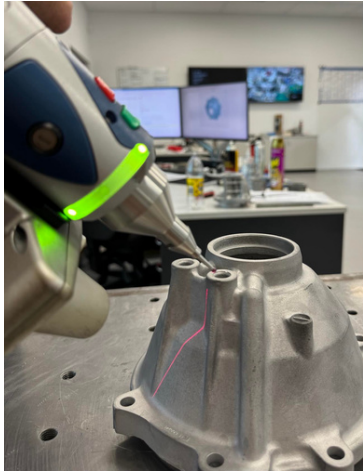
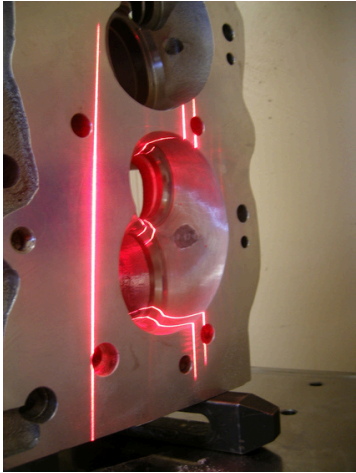



Inspection & Testing

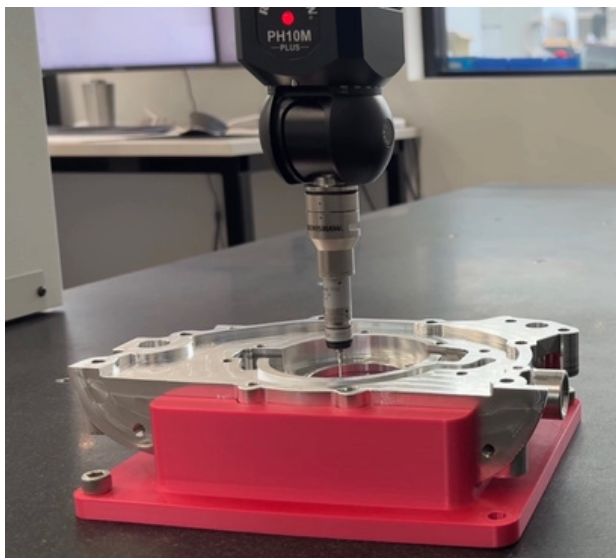
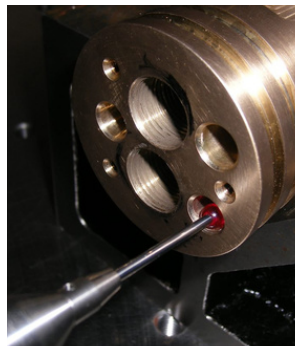
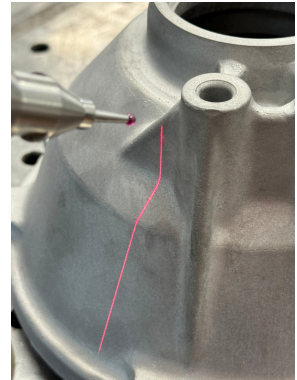
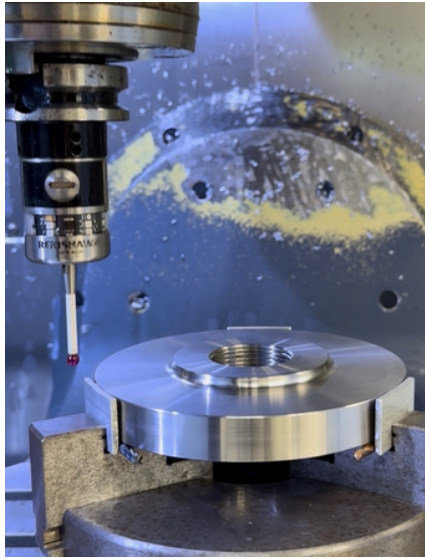
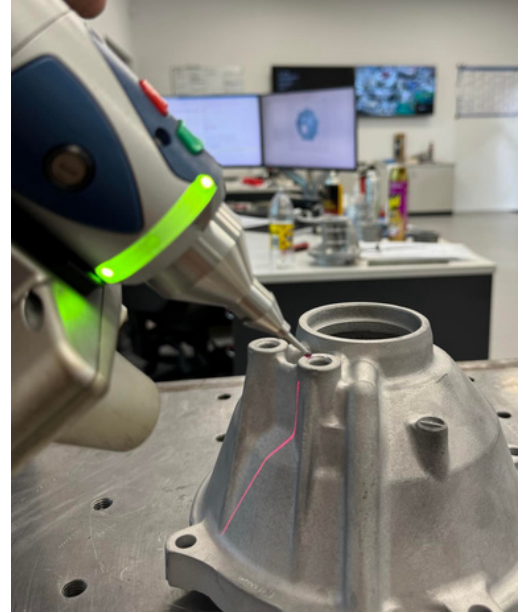



Assembly

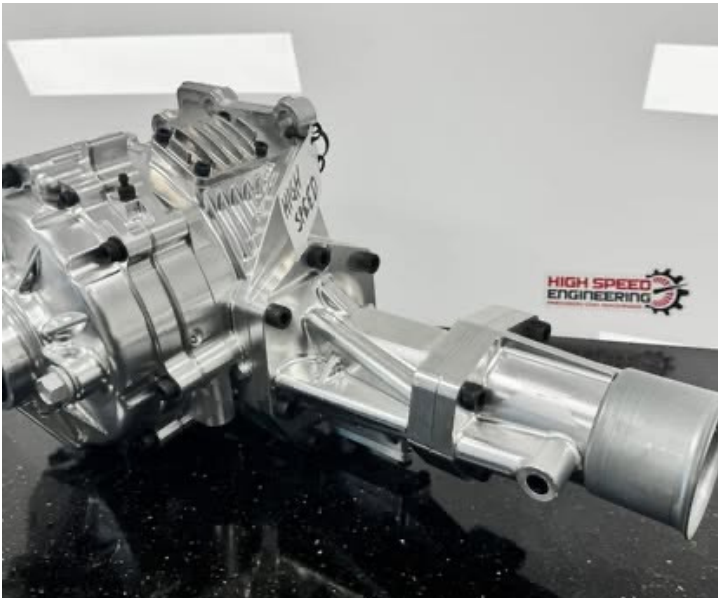
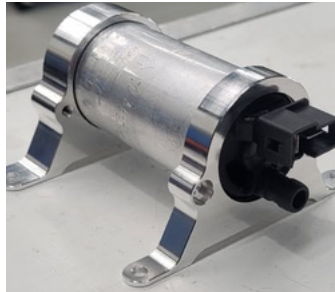
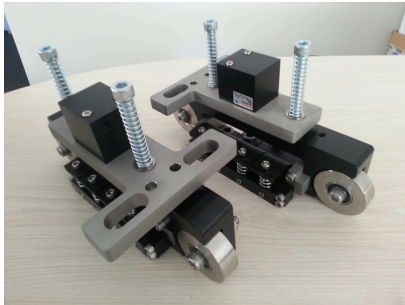

**HIGH SPEED
ENGINEERING**
PRECISION CNC MACHINING



15 Masonry Way
MALAGA WA 6090

P: 08 9248 1399

E: admin@highspeedengineering.com

W: www.highspeedengineering.com



CNC Precision Machined Parts 1/4

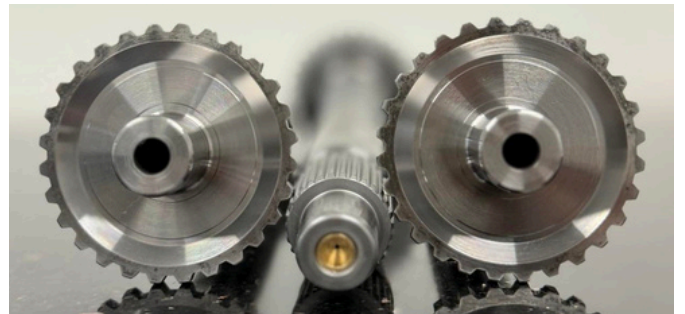
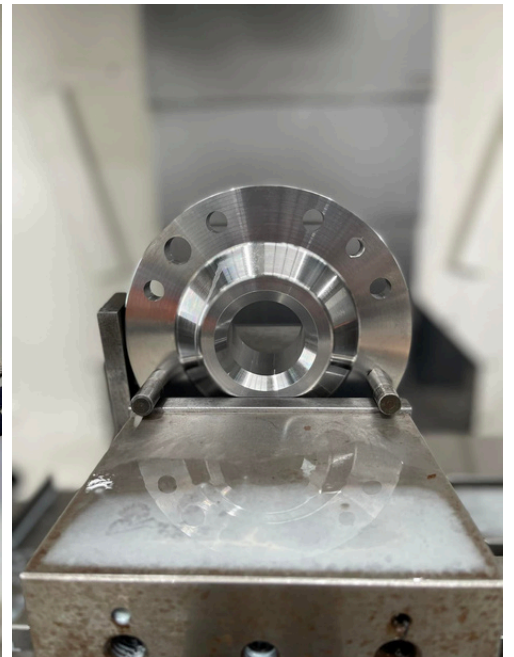
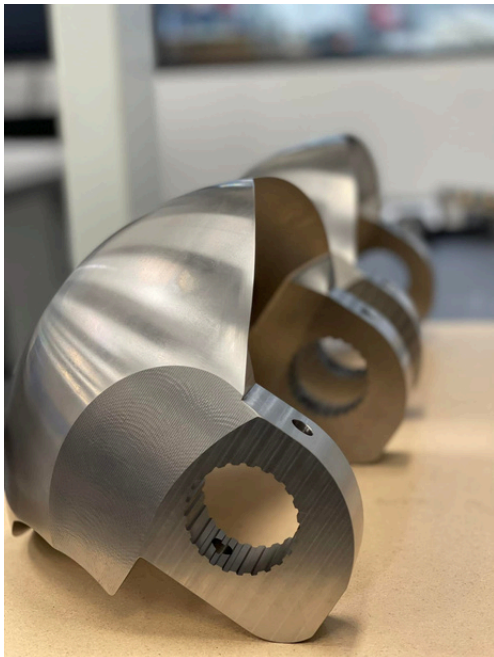
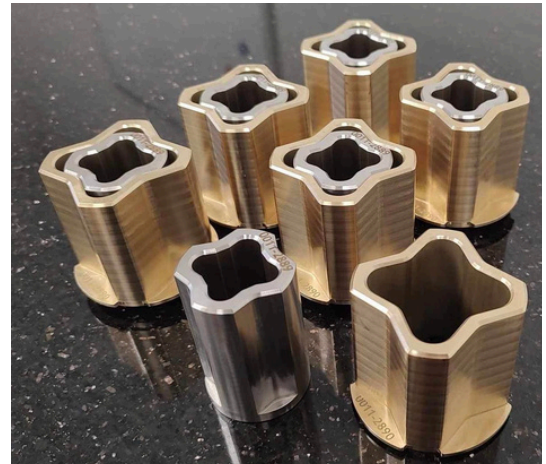
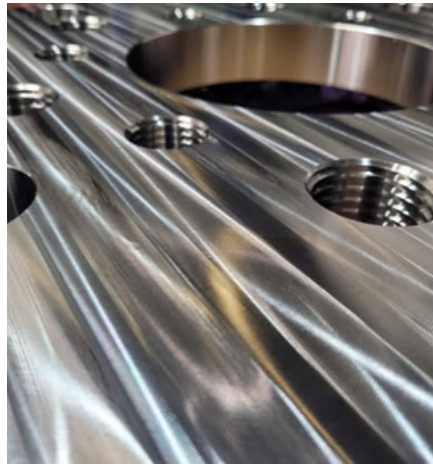
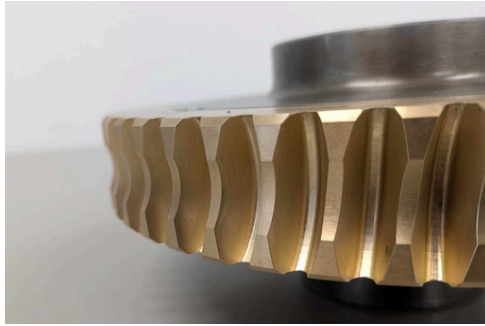



15 Masonry Way
MALAGA WA 6090

P: 08 9248 1399

E: admin@highspeedengineering.com

W: www.highspeedengineering.com



CNC Precision Machined Parts 2/4

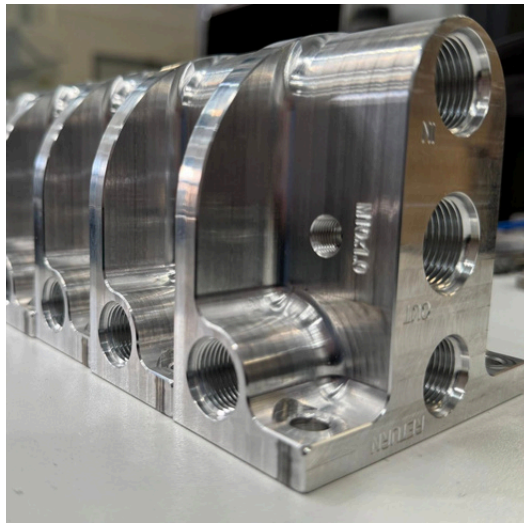
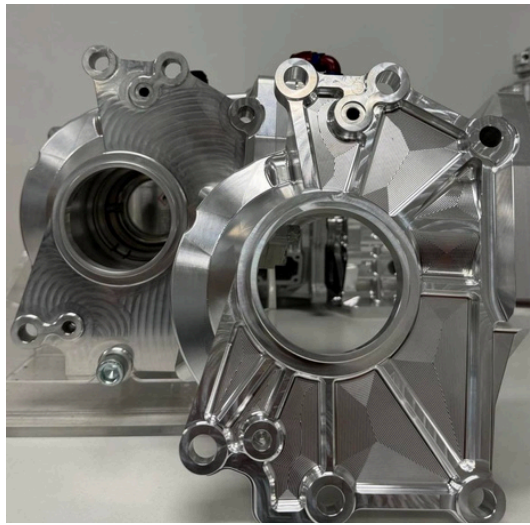
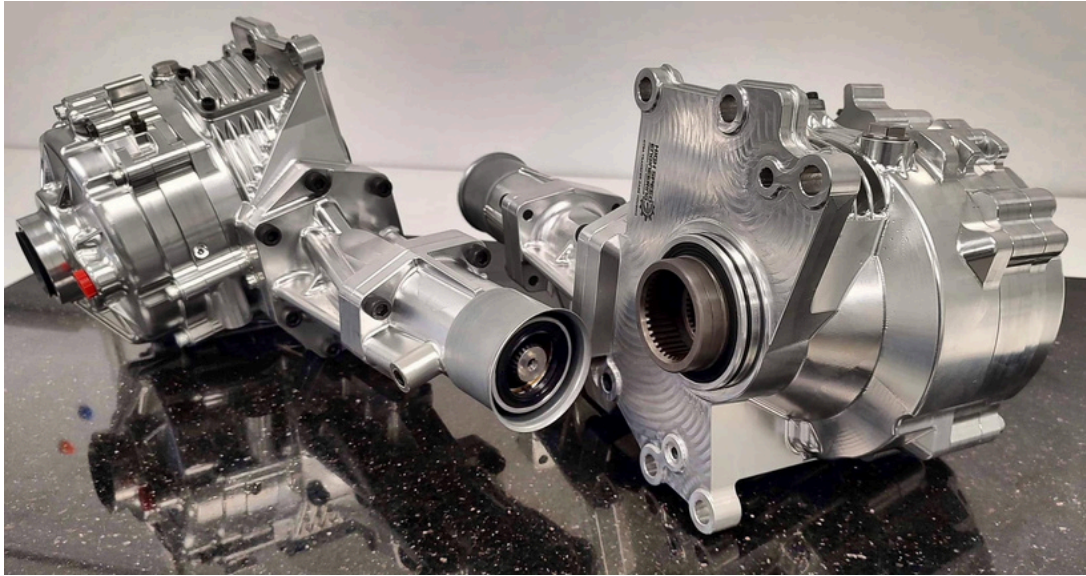

CNC Precision Machined Parts 3/4

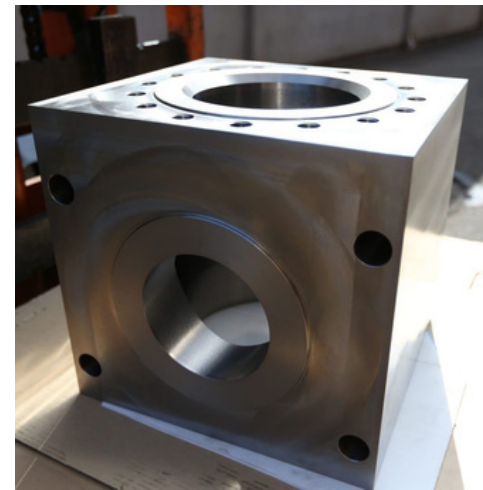



CNC Precision Machined Parts 4/4





High Speed Engineering specialises in the design, development and/or production of high-quality engineering components and precision parts through CNC machining, specialised engineering services, 3D printing and fabrication for all types of industries.

15 Masonry Way
MALAGA WA 6090
P: 08 9248 1399
E: admin@highspeedengineering.com
W: www.highspeedengineering.com
ABN: 87 368 749 427



Capabilities

Specialised Computer Numerical Control (CNC) Machining &
Other Technologies & Specialties

- Milling:** 3, 4 & 5 Axis CNC Machining Centres incl. 10 Pallet
Turning: 3, Y and C Axis Lathes
Wirecutting: 5 & 6 Axis Wirecutters incl. Excetek V650G+
Gear Hobbing: 4 Axis CNC
Welding: Robotic Mig Welder ABB IRB
Laser Cutting: 1500 x 1500mm area. Up to 25mm steel
Additive Manufacturing: FDM & Resin

Key Markets

Local, National & International Reach

- General Engineering
- Mining
- Valves
- Heavy Rail
- Subsea
- Oil & Gas
- Aerospace
- Bespoke Products
- Scientific
- Motorsport
- Component Repair

Discriminators

- ISO Accredited
- Small Business w/ High Capability, Capacity & Flexibility
- Team of Long Serving CNC Machining Specialists (incl. Company Owner)
- Clean & modern work premises
- 22+ Years in Business

Strategic Advantage

- Technology and efficiency focused
- Complex Engineering Components
- Manufacturing with Exotic Metals

Key Contacts:

Dennis Heller

Director
E: dennis@highspeedengineering.com
M: 0419 802 398

Sherrill Richardson

New Business Co-ordinator / Admin
E: sherrill@highspeedengineering.com
M: 0408 892 334